



智能数显压力温度一体仪表
Z901/Z801/Z601 系列
使用说明书

目录

目录.....	1
1. 概述.....	3
2. 选型指南.....	4
3. 主要技术指标及性能.....	5
4. 仪表外观尺寸和安装尺寸 (mm)	6
5. 仪表面板介绍	
5.1 仪表显示.....	9
5.2 指示灯.....	10
5.3 按键说明.....	10
6. 仪表接线	
6.1 输入接线.....	11
6.1.1 传感器输入接线.....	11
6.1.2 电流 4-20mA 输入接线.....	11
6.1.3 电压 0-5V/10V 输入接线	12
6.1.4 温度热电偶输入.....	12

6.2 仪表整机电源接线.....	13
6.3 输出.....	13
6.3.1 OUT 输出 固定为继电器上限报警.....	13
6.3.2 AL-1 通道输出默认为继电器输出;.....	13
6.3.3 AL-1 输出:	13
6.3.4 AL-3 通道输出:	14
6.3.5 AL-4 通道固定为继电器输出.....	14
7. 仪表操作	
7.1 仪表.....	16
7.2 仪表的主菜单.....	17
7.3 辅助报警菜单.....	28
8. 售后服务.....	30
9. 出厂配置.....	31

1. 概述

Z 系列智能数字表与各类模拟量输出的传感器,变送器电流(4-20mA)、电压(0-5V,0-10V)、桥路 mV/V 等信号类型配套使用,同时测量温度输入。输出继电器控制,电流,电压变送器,RS485 通讯,RS232 通讯等输出。整机采用开关电源。抗干扰等级达 4800V 群脉冲。

2. 选型指南

基本形式	仪表类型	供电电压	压力量程	输入信号	温度输入	输出信号	参数描述
Z							智能显示仪表
	901						正方形, 外形尺寸: 96 * 96
	801						竖式, 外形尺寸: 48 * 96
	601						横式, 外形尺寸: 96 * 48
		V1					85 ~ 265 VAC
		V2					24 V dc
			Mx				M 为 MPa, x 为数值
				S1			1.5 mV/V 输入
				S2			2 mV/V 输入
				S3			3.33 mV/V 输入
				S4			4 - 20 mA 输入
				S5			0 -10Vdc 输入
				S6			0 - 5 Vdc 输入
					K		K 型热电偶
					E		E 型热电偶
					J		J 型热电偶
					RTD		PT100铂电阻
						H1	2 路继电器输出(标准配置)
						H2	2 路继电器输出 + 1 路继电器输出
						H3	2 路继电器输出 + 4 ~20 mA 输出
						H4	2 路继电器输出 + 0 ~10 Vdc 输出
						H5	2 路继电器输出 + 0 ~5 Vdc 输出
						H6	2 路继电器输出 + RS 485 输出
						H7	2 路继电器输出 + RS 232 输出

3. 主要技术指标及性能

(1)显示 器： 双层四位高亮度 LED 数码显示

(2)分 辨 率： 0.001

(3)显示范围： 压力： 0000 - 9999 MPa (小数点可变)、温度： 000.1-400.0

(4)仪表精度： 0.2%FS \pm 1 位

(5)输 出： 继电器输出,4-20mA,0-5V,0-10V, RS485/RS232 通讯

(6)输 出： 采样速度： 50 次/ 秒

(7)使用温度： -10 ~ 50°C

(8)供电电源： 85 ~ 265V AC ; 24V DC

(9)重 量 约： 400 克(Z901); 280 克(Z801/Z601)

4. 仪表外观尺寸和安装尺寸 (mm)

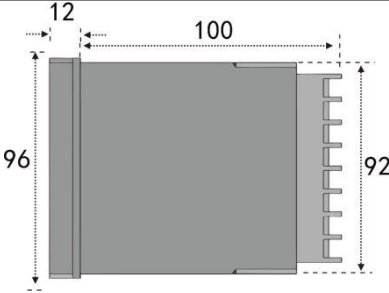
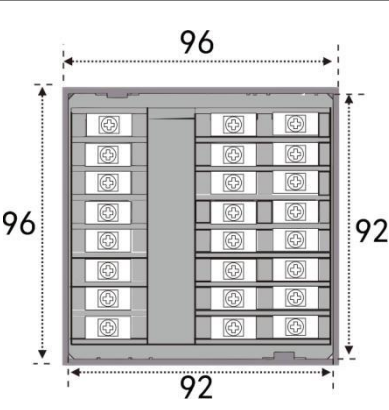
仪表型号	俯视图	后视图
<p>Z901</p> 		

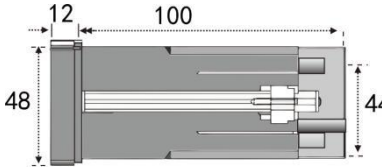
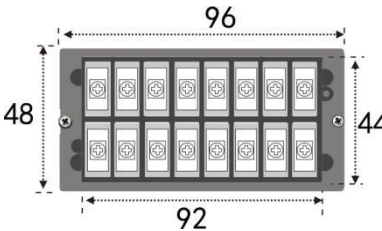
仪表型号	俯视图	后视图
<p>Z601</p> 		

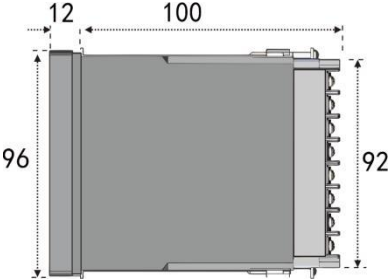
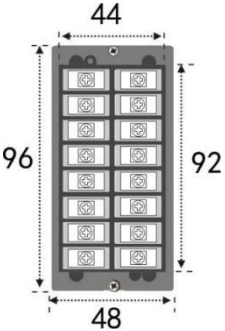
仪表型号	俯视图	后视图
<p>Z801</p>  <p>The photograph shows the Z801 instrument, a black rectangular device with a digital display showing '35.5' in red and '35.5 °C' in green. Below the display are several buttons and indicators, including 'SET', 'OK', and 'Ziasiot Z801'.</p>	 <p>The top view diagram shows the instrument's dimensions: a total width of 100, a mounting flange width of 12, and a height of 96. The right side shows a terminal block with a height of 92.</p>	 <p>The rear view diagram shows the terminal block dimensions: a width of 44, a height of 92, and a depth of 48. The terminal block contains a 4x3 grid of terminals.</p>

5. 仪表面板介绍

5.1 仪表显示

- 仪表采用双排 4 位高亮度 LED 显示数码管；

上排 4 位红色 5 寸数码管；**8.8.8.8.**

下排采用 0.39 英寸的墨绿色数码管。**8.8.8.8.**

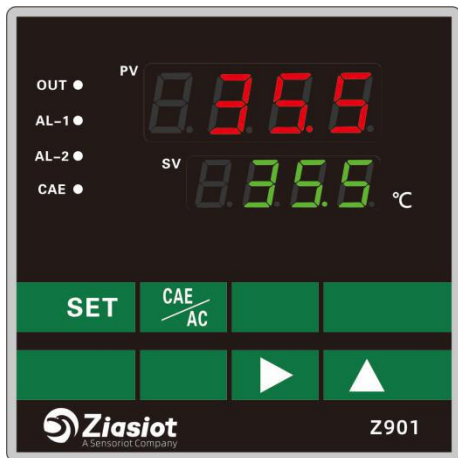

5.2 指示灯

仪表有四个指示灯,分别为 OUT,AL-1,AL-2,CAE

OUT ● 当 OUT 继电器报警吸合时,OUT 指示灯亮;反之,OUT 指示灯灭。

AL-1 ● 当 AL-1 继电器报警吸合时,AL-1 指示灯亮;反之,AL-1 指示灯灭。

AL-2 ● 当 AL-2 继电器报警吸合时,AL-2 指示灯亮;反之,AL-2 指示灯灭。

CAE ● 当传感器带有 80%校准功能,在主菜单校准子菜单中,使用。

5.3 仪表按键说明

SET 为功能键,点按可切换到不同菜单;长按可进入或退出主菜单。

CAE AC 清零和 80%校准复合键,只有点按操作。

➤ 移位键,只有点按操作。

⬆ 向上键,只有点按操作。

注:移位键和向上键用来设置菜单中的数据。

6. 仪表接线

6.1 输入信号

6.1.1 传感器信号输入(1~4mV/V)

仪表 1 号端子接传感器的 S+
 仪表 2 号端子接传感器的 E+
 仪表 3 号端子接传感器的 S-
 仪表 4 号端子接传感器的 E-仪表 5 号端子接传感器的 CAL 仪表 6 号端子接传感器的 Shield
 注：有传感器的没有校准信号,就不用接

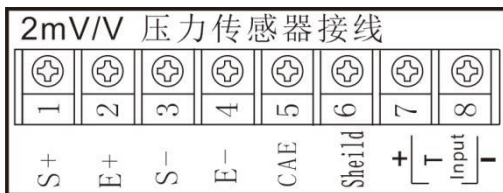

6.1.2 变送器两线制 4~20mA 输入

仪表 1 号端子接变送器的输入
 仪表 2 号端子接变送器的电源
 备注：电源正端一般为红线。

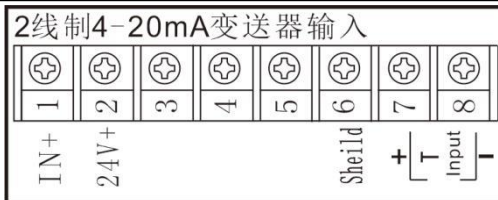

6.1.3 电压型变送器 0-5V 或 0-10V 输入接线

仪表 1 号端子接变送器的输出

仪表 2 号端子接变送器的电源正端

仪表 3,4 号端子共地

(电源与输出的地)

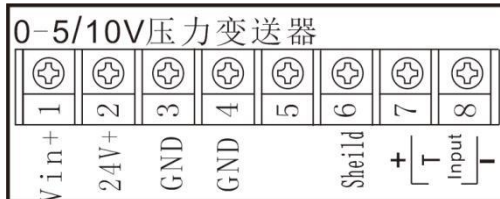

6.1.4 温度热电偶输入

仪表 7 号端子接热电偶的正端

仪表 8 号端子接热电偶的负端。

6.2 仪表整机电源接线

6.2.1 交流电接线

注:仪表整机开关电源,供电范围 85~265VAC, 仪表 14,15 号端子接交流电源 L,N 端。

6.2.2 直流 24V 接线(非标)

仪表 15 号端子接 24V 电源的正端; 仪表 14 号端子接 24V 电源的负端

6.3 输出

6.3.1 OUT 输出 固定为继电器上限报警

仪表 12 号端子为公共端；仪表 11 号端子为常闭端；仪表 13 号端子为常开端

6.3.2 AL-1 通道输出默认为继电器输出；

也可以电流电压输出订货时,说明。仪表 9, 10 号端子为继电器输出

6.3.3 AL-2 输出：

可继电器输出，电流电压。

6.3.3.1 继电器输出

仪表 7 号,8 号脚为继电器输出

6.3.3.2 电流或电压输出

仪表 7 号端子为正，8 号端子为负

6.3.4 AL-3 通道输出:

继电器或者 RS485 通讯仪表 20, 21 端子

6.3.4.1 继电器输出

6.3.4.2 RS485 通讯输出

仪表 21 号端子为 B 端, 20 号为 A 端

6.3.5 AL-4 通道固定为继电器输出

仪表端子为 22, 23, 24

20 脚 A(+), 21 脚 B(-)

当选择为 RS232 时, RS232 通讯输出。

当选择为继电器输出, 20, 21 脚输出









7. 仪表操作









7.1 仪表

分 2 级菜单：主菜单和辅助报警菜单

- (1)在正常工作状态下,通过 **SET** 长键三秒钟以上就来进入主菜单;
在主菜单任意一子菜单中,按 **SET** 长键三秒以上,均退出主菜单,返回工作状态。
- (2)在正常工作状态下,点按 **SET** 键,就进入辅助报警菜单。
- (3)不论在主菜单还是辅助报警菜单中,要想切换下一个子菜单,只需要按一下 **SET** 键就可以了。
- (4)不同的子菜单中,根据菜单具体内容,使用相应的其它按键。









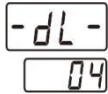
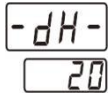

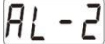

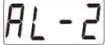

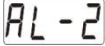

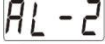

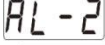
7.2 仪表的主菜单

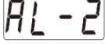

菜单项	菜单符号	主菜单说明	操作
1	 	压力清零	当系统压力为 0,仪表不显示为 0,按  键一下,清零,并进入下一菜单。
2	   	传感器的量程设置	<p>-Ed-为传感器量程的上端。 -Ld-为量程的下端。它们之间通过键切换。</p> <p>设置具体参数通过   键</p>





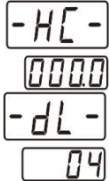

3		压力 80%校准	<p>1, 接带有 80%校准功能的传感器有效。在传感器空载时, 上下两排数据相差大的时候, 按一下  键校准。</p> <p>2, 不带 80%校准的传感器或者变送器输入, 一律按  键, 将下排修改成  。</p>
4		零点满度标定	<p>1, 传感器空载时, 按一下  键, 出现  提示符; 2, 加载到满量程, 按下  键, 下排出现闪烁; 3, 按一下  键, 进入下一菜单, 同时标定数据保存。</p> <p>注: 此菜单慎用! 出厂前, 厂家已标定好!</p>

5	<p>AL-1</p> <p>PHU</p> <p>AL-1</p> <p>PLU</p> <p>AL-1</p> <p>P-1</p> <p>AL-1</p> <p>°CHU</p> <p>AL-1</p> <p>°CLU</p> <p>AL-1</p> <p>°C-1</p>	AL-1 输出方 式选择	<p>AL-1 输出方式选择：</p> <p>PHU为压力上限继电器报警</p> <p>PLU为压力下限继电器报警</p> <p>°CHU为温度上限继电器报警</p> <p>°CLU为温度下限继电器报警</p> <p>P-1为压力电流或者电压输出</p> <p>°C-1为温度电流或者电压输出</p> <p>通过\blacktriangle键来选择。</p>
---	--	-----------------	--











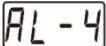



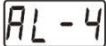

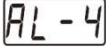

6		AL-1 设置 1	<p>-HL-当在菜单 5 中,AL-1 设置为 PHJ,PLJ, °CHJ,°CLJ 时,,表示继电器回差值设置。</p> <p>-dL-当在菜单 5 中,AL-1 设置为 P-I 或 °C-I 时,表示电流或者电压输出下限。</p> <p>注:电流输出时默认为 04; 当电压输出默认为 0.电压 0V 输出。</p>
7		AL-1 设置 2	<p>-dH-当在菜单 5 中,AL-1 设置为 P-I 或 °C-I 时,表示电流或者电压输出上限。</p> <p>注:默认为 20;当电流输出上限为 20mA;或者电压输出上限 10V 输出。</p>





8	           	AL-2 输出方 式选择	<p>AL-2 输出方式选择：</p> <p>为压力上限继电器报警</p> <p>为压力下限继电器报警</p> <p>为温度上限继电器报警</p> <p>为温度下限继电器报警</p> <p>为压力电流或者电压输出</p> <p>为温度电流或者电压输出</p> <p>通过  键来选择。</p>
---	--	-----------------	---





9		AL-2 设置 1	<p>-HC-继电器输出时, 回差值设置</p> <p>-dL-电流输出下端, 默认为 04; 电压输出下端, 默认为 00;</p>
10		AL-2 设置 2	<p>-dH-当在菜单 5 中,AL-1 设置为 P-I 或 °C-I 时,表示电流或者电压输出上限。 默认为 20;</p>



11	 <p>The image shows a vertical menu for selecting the AL-3 output mode. It consists of nine rectangular buttons stacked vertically. The first three buttons are labeled 'AL-3', 'PHJ', and 'AL-3'. The next three buttons are labeled 'PLJ', 'AL-3', and 'CHJ'. The final two buttons are labeled 'AL-3' and '485'.</p>	AL-3 输出方 式选择	<p>AL-3 输出方式选择：</p> <p> 为压力上限继电器报警</p> <p> 为压力下限继电器报警</p> <p> 为温度上限继电器报警</p> <p> 为温度下限继电器报警</p> <p> 为 RS485 通讯输出</p> <p>通过  键来选择。</p>
----	--	-----------------	---

12		AL-3 设置 1	<p>-HC- 当在菜单 11 中,AL-3 设置为 PHJ,PLJ, °CHJ,°CLJ 时,表示继电器回差值设置。</p> <p>Add 当在菜单 11 中,AL-3 设置 485 时,设置仪表通讯地址。波特率 9600.</p>
----	---	-----------	---

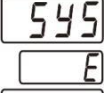
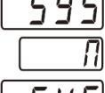
13	       	AL-4 输出方式选择	<p>AL-4 输出方式选择：</p> <p>为压力上限继电器报警</p> <p>为压力下限继电器报警</p> <p>为温度上限继电器报警</p> <p>为温度下限继电器报警</p> <p>通过  键来选择。</p>
14	 	AL-4 设置 2	<p>为 AL-4 继电器的回差值。具体通过   来设置参数。</p>

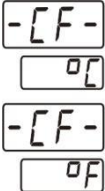

15		滤波参数	<p>千位为 2,仪表备份数据;1 时,按一下  键,恢复出厂标定数据;</p> <p>百位为 OUT 继电器输出延时 0,不延时;1 延时 1S;2 延时 2S;</p> <p>十位为采样滤波,范围:1-4;</p> <p>个位为显示滤波,范围:1-8.</p>
16		小数点设置	小数点设置通过  键来设置
17		内码查看	仪表内码显示,只看,不可修改。

18	    	<p>温度传感器 热电偶型号 选择</p>	<p>K 型热电偶 J 型热电偶 E 型热电偶 N 型热电偶 T 型热电偶</p>
----	---	-------------------------------	---

19		<p>显示温度值 偏差修正</p>	<p>当显示温度值大于实际值时，SC 输入负差值;反之,输入正差值。</p>
20		<p>华氏摄氏度 显示选</p>	<p>°C 仪表显示摄氏度温度值 °F 仪表显示华氏温度值</p>
21		<p>键盘锁</p>	<p>0:主菜单和辅助菜单不锁 1:只锁主菜单 2:主菜单和辅助菜单都锁.</p>

7.3 辅助报警菜单

在工作状态下,按一下 SET 键,就进入辅助报警菜单 1 报警设置中。

菜单项	菜单符号	主菜单说明	操作
1		OUT 报警值 设置	UT 继电器固定为上限报警。 OUT 报警值通过 > ^ 键设置参数
2		AL-1 报警值 设置	AL-1 通过主菜单中 AL-1 报警方式来设置上限(HJ)或下限(LJ)报警。 AL-1 报警值通过 > ^ 键参数。

3		AL-2 报警值 设置	<p>AL-2 通过主菜单中 AL-2 报警方式来设置上限(H)或下限(L)报警.</p> <p>AL-2 报警值通过   键参数。</p> <p>当主菜单 AL-2 设置为电流或电压输出时,此菜单不出现, 直接返回工作状态。</p>
4		AL-3 继电器 报警值设置	<p>AL-3 通道作为继电器输出时, 出现此菜单。报警值警值通过   键设置参数</p>
5		AL-4 报警值 设置	<p>AL-4 报警值通过   键参数。</p>

8. 售后服务

①打开包装箱后,请检查产品与您订货要求是否一致,包装,产品有无损坏,配件是否齐全完好,若发现有误,请速与我公司联系。

②自发货之日起一年内因产品本身问题我公司负责免费维修,且终身保修。

③以下情况不属于保修范围:

未按本说明书正确安装,使用,人为造成产品损坏。

用户擅自对产品进行维修或改造。

因不可抗的外力对产品造成损坏。

产品标牌不清或丢失,产品外观严重破损的。

④如使用中产品出现故障,请妥善保管故障产品,及时与我公司联系,说明故障现象,公司将及时提供技术支持。切勿擅自修理。

9. 出厂配置

序号	名称	单位	数量	备注
1	仪表	台	1	标配
2	仪表支架	个	2	标配
3	说明书	份	1	标配
4	合格证	份	1	标配



上海申狮物联网科技有限公司
Shanghai Sensoriot Technology Co., Ltd
上海市松江区联营路 615 号 18 幢 6 楼 邮编: 201611
电话: +86-21-64930577 传真: +86-21-37635507
邮箱: zias@ziasiot.com 免费热线: 400-821-0137
网址: www.ziasiot.com

